

ASSEMBLY INSTRUCTIONS

VF47024MBL / VF47024MGN / VF47024MWT
VF47024MTK / VF47024MMP

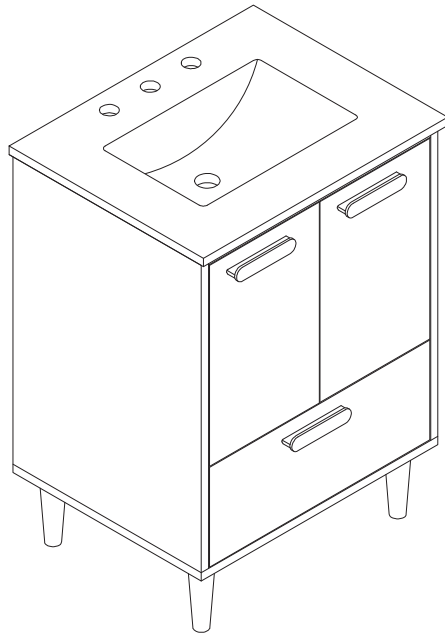

Step 1

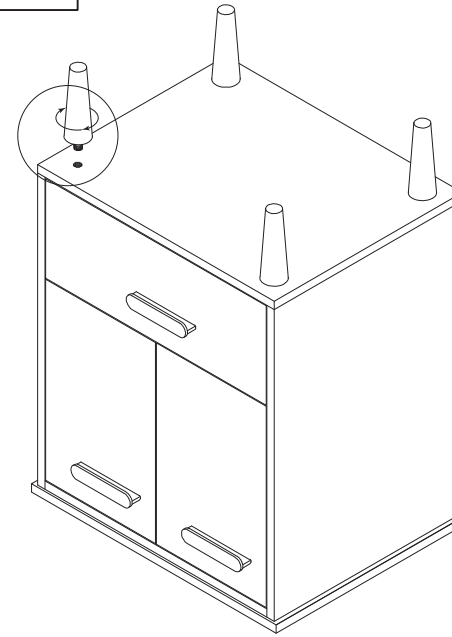

warning: Use two people to lift the vanity. Upon turning over the vanity upright, do not allow pressure to apply to one single leg or one single side.

Step 2

